

Hager Dream
wiring accessories

live your Dream



:hager

Milestones of Hager wiring accessories



1919

Berker Brothers began to manufacture the first batch of rotary switches in Schalksmühle. Every detail was as simple, elegant, and functional as all Berker's other subsequent models.



1948

Traditionally, water-proof switches are made of cast resin or ceramics. Therefore, Berker's molded plastics rotary switch is a real innovation. The threads of the rotary switch are pressed into the top of the gland cover and grease cavity seals are installed on the axle. This type of switches features optimal waterproof performance. Its basic design features remained unchanged for decades of years.

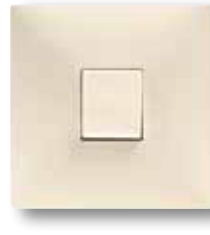

1966

Although it seems quite natural today, dating back to 1966, the launch of a switch equipped with a dismountable switch cover that can be backfilled after the completion of the painting engineering indicated a significant innovation and great progress in terms of convenience. Moreover, since the switch cover is easy to change, many of the 1966 rocker switches are still in good keep today and can still work normally.



1980

The combination of circle and square was one of our most successful products in the grim technical environment in the 1980s.



1996

'Twinpoint' design has interchangeable decorative rings, which provides all kinds of design possibilities



1928

Form + Function: When Bauhaus began to carry this concept forward, Berker Brothers have turned to the famous architect Louis Henri Sullivan's design concept. Functional and perfect design combined with reliable technology—Berker's switches already had all the elements that a product needs to become classic. These products later became classic indeed.



1957

The cover of this type of switch is as colorful as any of the modern works of art—That is why this colorful sample is called 'Chagall'.



1972

A big success, where modularization is used, the first type of stainless all-metal switch— Another real innovation.



1983

An expert to deal with difficult tasks: 'ISO-Panzer' has excellent waterproof and shockproof performances excellent waterproof and shockproof performances



1999

TS series can not only assist in creating special lighting effect, but can also combine KNX system for operating the complete smart home system.



2003

Full ranges included system 8000, 9000, 9088 metal ranges for Asia launched.



2008

The greatest feature of TS Crystal Ball is its glittering Swarovski crystal and sensitive optical reflection sensor, very charming.



2009

Touch of style as system 10088 equipped with large rocker and blue LED indication.



2016

Berker Q.7 not only highlights its form, functions, and craftsmanship, but also lifts architectural individuality and material application to a higher level.



2020

Hager Dream, Hager Inspire, Hager Muse with best-in-class aesthetics design, quality and full functions to answer all needs.



2004

Intelligence is a kind of beauty. Undoubtedly, B.IQ looks very beautiful: The first type of smart and fashionable home control unit in the world indicates the arrival of the new era of comfort.



2007

Only by touching... That is the artistic state to start to control a room. Technical progress makes it possible for us to combine minimalism with modern technology and create a new exchange mode.



2011

R.1 series explains its design of round angle of the excircle in its unique way. It has a soft framework outline and all kinds of functional versions. It is a good choice for all residential and decoration projects.



2013

stylea with slim and nice profile large rocker provided affordable option.



2018

Dream series, designed by the European designer, Erwin van Handenhoven, a winner of many international awards, bring elegant life experience to customers.

**Dream
with
ambition**

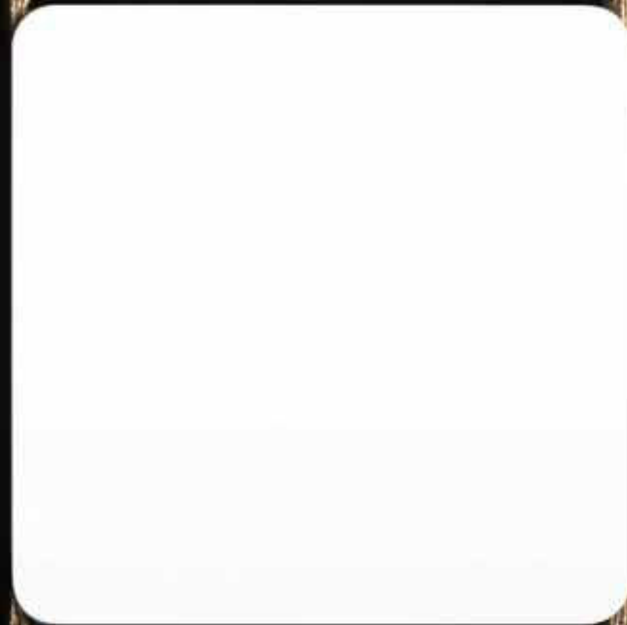

Frameless design

The ultra-slim, frameless design allows the switch to be integrated into the wall; the simple and large panel makes the contact easy, and each touch creates the most pleasant moment.

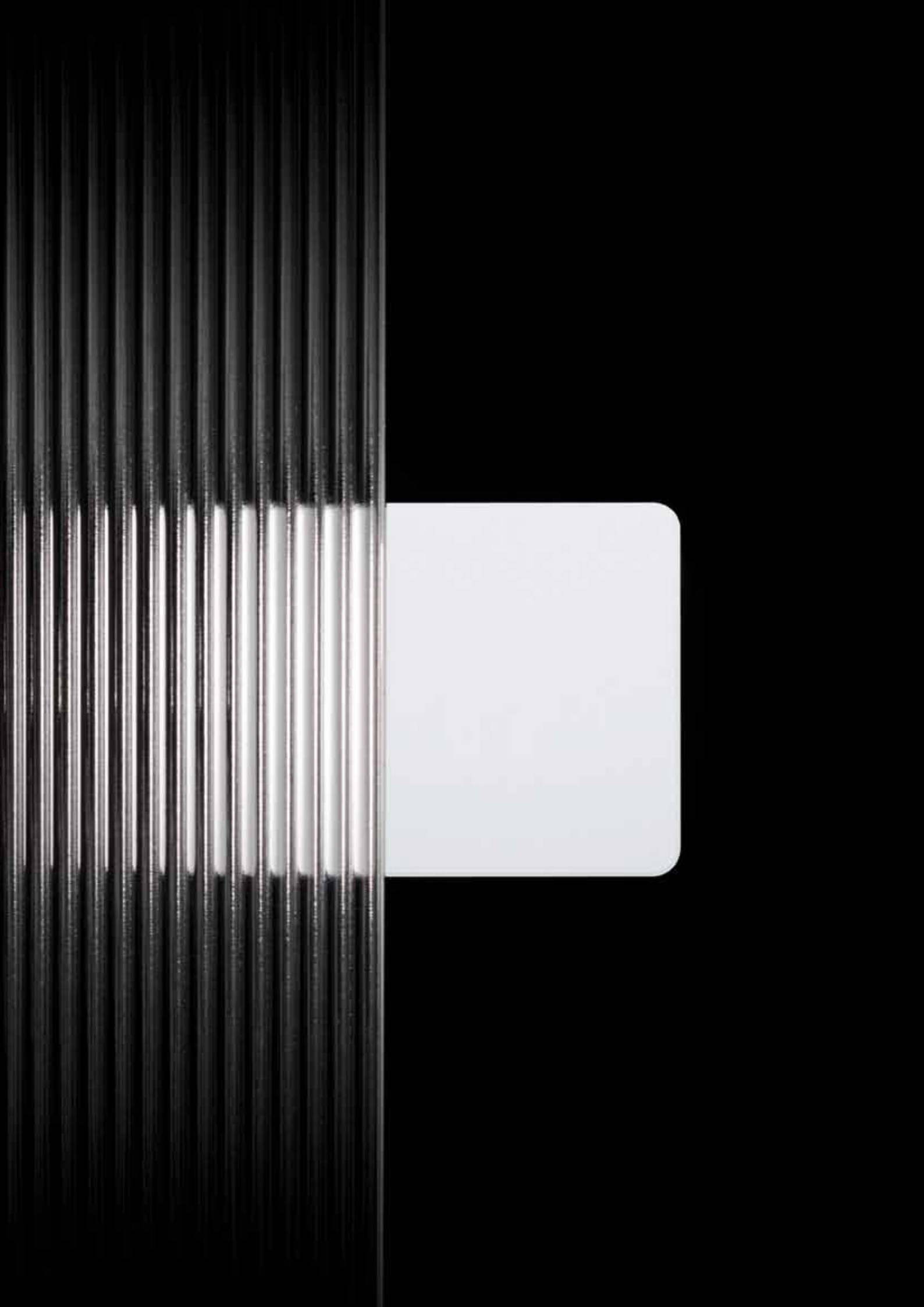

Hidden LED

Soft and discrete LED light to locate the switch as soon as you enter the room. No need to feel your way in the dark. Guided by the LED light, experience the convenience and safety.



Multiple choices of color for your switch

Pursue uniqueness and elegance, white, elegant gold, interstellar grey, noble bronze and knight black, the color tone personifies the style and poise.



Multiple choices of color for the switch ring

Details are carefully deliberated in the design.
Ultra-slim panel with changeable colored ring
is trendy and stylish.





Expert tips



01

Frameless design

The ultrathin and frameless appearance design makes the switch integrate with the wall into an integral whole; the simple but huge rocker makes contact very easy, and each touch creates the most touching moment.



02

Hidden LED

Soft and distinguishable LED light, you can find where the switch is located as soon as you enter the room, and you needn't feel your way in the dark to get up in the night. Guided by LED light, you will experience convenience and safety.



03

Identification for power

Humanized delayed power off is designed, which saves power in a smart way. The insert tag switch has an LED indicator, which makes it easy for you to find the slot in the dark. After power on, the indicator will turn off automatically.



04

Noise reduction design

Noise reduction is designed for the large switch panel, which embodies the sound and hand feeling of the products imported from Europe. The design idea from multi-dimensions such as impression, light perception, sense of touch, and phonoreception makes the large rocker perfect.

05

U type screwed terminals

Capacity of terminal can fit 3 x 4mm² flexible/ rigid wire. However, it is easy to wiring, high efficient for installation.

06

Beehive-like support

Beehive structure has the advantages of super-strong intensity and light weight. It is accurately used for the installing support of the product, which makes it more firm, durable, and not deformed over time.



07

Color-changeable switch ring

The switch rings of Dream series can change colors to match the interior decoration as you like, providing more possibilities for the overall design.



08

IP55 waterproof box

The integrated production makes the waterproof and dustproof functions reach the high waterproof level of IP55. The design of a transparent large space box provides more space for the power cable to turn naturally, realizing real waterproof at power consumption.



09

Safety and stability

The international standard rated current of switch is 16AX, which ensures safer and more stable use of the switch.



10

Shutter

Having safety awareness all the time comes from the care for every family member. The socket panel is designed with child lock. The socket panel is designed with child lock. Source isolating safety shutter is installed at the jacks to prevent children from putting their single finger in. It can completely block current.



11

Surge protection capability

The surge capability of electronic products can reach 2500V, it is 2.5 times higher than standard.



12

Monobloc rocker & frame design

Rocker and the frame can be taken out by one time only, easy for installation. This is a perfect alignment of rockers all the time.



13

USB charger

4.2A, 5V charger is suitable for all kinds of electronic devices (1 type C + 2 type A). No need for extra charger, can be easily charged via USB cable, it also can be used for charging 3 devices at the same time.



14

Certified by British Nemko

The shaver socket is certified by British Nemko. Grade II safety isolating transformer is used, which makes transformation safer and products more durable.



15

Dust-protection Cover

Dust-protection cover is supplied for each product. It can be used for protecting the dust during decorating, keeping the product clean.



16

Ensuring communication quality

The network socket ensures communication quality. It is certified by UL lab and ensures high-quality communication.

17

Eco-packaging

We adhere to environmental philosophy all the time and won international iF design award for the packaging.



18

Designed by European master

Designed by Erwin van Handenhoven, who has won many international awards.

Hager Dream series



Hager Dream series	Page
Wall switches	18-19
Dimmer and fan controller switches	19
Double pole control switches	20
Connection unit	21
5A and 10A socket outlets	22
13A socket outlets	22
15A and 16A socket outlets	23
Communication and data	24
Hotel range	25
Others	26
Product standard	27
Ingress protection	30
Circuit diagram	31
Application	34
Success cases	40

- Complies with IEC 60669-1 CB certificate

- 'AX' rated - No need to derate for fluorescent loads

- Supplied with M3.5 x 37 mm long fixing screws

- Capacity of each terminal:
3 x 1.5 mm²
2 X 4.0 mm²

- Two way switches can be wired either 1 way or 2 way

- Terminal markings denote:
L1 = one way
L2 = two way
C = common

- Material: Polycarbonate

Description		Pack qty.	Cat. Ref. White	Cat. Ref. Interstellar Grey	Cat. Ref. Noble Bronze	Cat. Ref. Knight Black	Cat. Ref. Elegant Gold
Large dolly switch							
 WGDL111 WGDL112	16AX, 1 gang 1 way	10	WGDL111	WGDL111IG	WGDL111NB	WGDL111KB	WGDL111EG
 WGDL121 WGDL122	16AX, 1 gang 2 way	10	WGDL112	WGDL112IG	WGDL112NB	WGDL112KB	WGDL112EG
 WGDL121 WGDL122	16AX, 2 gang 1 way	10	WGDL121	WGDL121IG	WGDL121NB	WGDL121KB	WGDL121EG
 WGDL122 WGDL122	16AX, 2 gang 2 way	10	WGDL122	WGDL122IG	WGDL122NB	WGDL122KB	WGDL122EG
 WGDL131 WGDL132	16AX, 3 gang 1 way	10	WGDL131	WGDL131IG	WGDL131NB	WGDL131KB	WGDL131EG
 WGDL141 WGDL142	16AX, 3 gang 2 way	10	WGDL132	WGDL132IG	WGDL132NB	WGDL132KB	WGDL132EG
 WGDL141 WGDL142	16AX, 4 gang 1 way	10	WGDL141	WGDL141IG	WGDL141NB	WGDL141KB	WGDL141EG
 WGDL142 WGDL142	16AX, 4 gang 2 way	10	WGDL142	WGDL142IG	WGDL142NB	WGDL142KB	WGDL142EG

Large dolly switch with LED							
 WGDL111N WGDL112N	16AX, 1 gang 1 way	10	WGDL111N	WGDL111NIG	WGDL111NNB	WGDL111NKB	WGDL111NEG
 WGDL121N WGDL122N	16AX, 1 gang 2 way	10	WGDL112N	WGDL112NIG	WGDL112NNB	WGDL112NKB	WGDL112NEG
 WGDL121N WGDL122N	16AX, 2 gang 1 way	10	WGDL121N	WGDL121NIG	WGDL121NNB	WGDL121NKB	WGDL121NEG
 WGDL122N WGDL122N	16AX, 2 gang 2 way	10	WGDL122N	WGDL122NIG	WGDL122NNB	WGDL122NKB	WGDL122NEG
 WGDL131N WGDL132N	16AX, 3 gang 1 way	10	WGDL131N	WGDL131NIG	WGDL131NNB	WGDL131NKB	WGDL131NEG
 WGDL132N WGDL132N	16AX, 3 gang 2 way	10	WGDL132N	WGDL132NIG	WGDL132NNB	WGDL132NKB	WGDL132NEG

Large dolly switch							
 WGDL113	10AX, 1 gang, intermediate	10	WGDL113	WGDL113IG	WGDL113NB	WGDL113KB	WGDL113EG
 WGDL111B	10A, 1 gang, bell switch mark Bell symbol	10	WGDL111B	WGDL111BIG	WGDL111BNB	WGDL111BKB	WGDL111BEG
 WGDL111E	10A, 1 gang, press switch mark "EXIT"	10	WGDL111E	WGDL111EIG	WGDL111ENB	WGDL111EKB	WGDL111EEG

Description	Pack qty.	Cat. Ref. White	Cat. Ref. Interstellar Grey	Cat. Ref. Noble Bronze	Cat. Ref. Knight Black	Cat. Ref. Elegant Gold
Press switch						
10A, 1 gang	10	WGDL111P	WGDL111PIG	WGDL111PNB	WGDL111PKB	WGDL111PEG
10A, 2 gang	10	WGDL121P	WGDL121PIG	WGDL121PNB	WGDL121PKB	WGDL121PEG
10A, 3 gang	10	WGDL131P	WGDL131PIG	WGDL131PNB	WGDL131PKB	WGDL131PEG
Press switch with 220V LED						
10A, 1 gang	10	WGDL111NP	WGDL111NPIG	WGDL111NPNB	WGDL111NPKB	WGDL111NPEG
10A, 2 gang	10	WGDL121NP	WGDL121NPIG	WGDL121NPNB	WGDL121NPKB	WGDL121NPEG
10A, 3 gang	10	WGDL131NP	WGDL131NPIG	WGDL131NPNB	WGDL131NPKB	WGDL131NPEG
Press switch with 12V LED						
10A, 1 gang	10	WGDL111NP-12V	WGDL111NP-12VIG	WGDL111NP-12VNB	WGDL111NP-12VKB	WGDL111NP-12VEG
10A, 2 gang	10	WGDL121NP-12V	WGDL121NP-12VIG	WGDL121NP-12VNB	WGDL121NP-12VKB	WGDL121NP-12VEG
10A, 3 gang	10	WGDL131NP-12V	WGDL131NP-12VIG	WGDL131NP-12VNB	WGDL131NP-12VKB	WGDL131NP-12VEG



WGDL111P
WGDL111NP



WGDL121P
WGDL121NP



WGDL131P
WGDL131NP

Hager Dream

Dimmer and fan controller switches

- Complies with IEC 60669-2-1
- Supplied with M3.5 x 37 mm long fixing screws
- Material: Polycarbonate
- Capacity of each terminal: 3 x 1.5 mm²

Description	Pack qty.	Cat. Ref. White	Cat. Ref. Interstellar Grey	Cat. Ref. Noble Bronze	Cat. Ref. Knight Black	Cat. Ref. Elegant Gold
Dimmer						
40-500W single, 2 way	6	WGDEDR500	WGDEDR500IG	WGDEDR500NB	WGDEDR500KB	WGDEDR500EG
Fan control						
250VA, single	6	WGDEFR250	WGDEFR250IG	WGDEFR250NB	WGDEFR250KB	WGDEFR250EG



WGDEDR500



WGDEFR250

- Complies with IEC 60669-1 CB certificate

- Supplied with M3.5 x 37 mm long fixing screws

- Capacity of each terminal:
20AX
L, N, E: 2 x 4 mm²

- Material: Polycarbonate

32A, 45A
L, N : 2.5 mm² ~ 16 mm²
E x 2 : 2.5 mm² ~ 16 mm²



WGDL2D1



WGDL2D2

Description	Pack qty.	Cat. Ref. White	Cat. Ref. Interstellar Grey	Cat. Ref. Noble Bronze	Cat. Ref. Knight Black	Cat. Ref. Elegant Gold

DP switch

20AX 1 gang	8	WGDL2D1	WGDL2D1IG	WGDL2D1NB	WGDL2D1KB	WGDL2D1EG
20AX 2 gang	8	WGDL2D2	WGDL2D2IG	WGDL2D2NB	WGDL2D2KB	WGDL2D2EG

Remark: Grey reference product - coming soon



WGDL2D1N
WGDL2D12N



WGDL2D2N

DP switch with LED

20AX 1 gang	8	WGDL2D1N	WGDL2D1NIG	WGDL2D1NNB	WGDL2D1NKB	WGDL2D1NEG
20AX 2 gang	8	WGDL2D2N	WGDL2D2NIG	WGDL2D2NNB	WGDL2D2NKB	WGDL2D2NEG
20AX 1 gang	8	WGDL2D12N	WGDL2D12NIG	WGDL2D12NNB	WGDL2D12NKB	WGDL2D12NEG

Special marks	Abbreviation	Special marks	Abbreviation	Special marks	Abbreviation
"AIR CONDITIONER"	AC	"HOB"	HB	"WASHER"	WS
"DISH WASHER"	DW	"HOOD"	HD	"WASHING MACHINE"	WM
"DRYER"	DR	"MICROWAVE"	MW	"WATER HEATER"	WH
"FRIDGE"	FR	"OVEN"	OV		

Example: **"WATER HEATER" WH**

20AX 1 gang **WGDL2D1WH WGDL2D1IGWH WGDL2D1NBWH WGDL2D1KBWH WGDL2D1EGWH**



WGDR32D1



WGDR45D1

Control switch with LED

32A DP	8	WGDR32D1	WGDR32D1IG	WGDR32D1NB	WGDR32D1KB	WGDR32D1EG
45A DP	8	WGDR45D1	WGDR45D1IG	WGDR45D1NB	WGDR45D1KB	WGDR45D1EG

- 25A Connection units
BS 5733
IEC 60998-1
IEC 60998-2-1

- Fused connection units
complies with
BS 1363-4

- Supplied with M3.5 x 37 mm
long fixing screws

- Capacity of each terminal:
25A
L, N, E: 4 x 2.5 mm² or 2 x 4 mm²
or 1 x 6 mm²

- Material: polycarbonate

13A FCU
L, N : 3 x 4.0 mm²
E : 2 x 4.0 mm²



WGDR25

Description	Pack qty.	Cat. Ref. White	Cat. Ref. Interstellar Grey	Cat. Ref. Noble Bronze	Cat. Ref. Knight Black	Cat. Ref. Elegant Gold
Connection unit 25A with flex outlet	12	WGDR25	WGDR25IG	WGDR25NB	WGDR25KB	WGDR25EG



WGDR13



WGDR13N



WGDR13S



WGDR13SN

Fused connection unit						
13A fused w/ flex outlet	10	WGDR13	WGDR13IG	WGDR13NB	WGDR13KB	WGDR13EG
13A fused w/ LED + flex outlet	10	WGDR13N	WGDR13NIG	WGDR13NNB	WGDR13NKB	WGDR13NEG
13A switched fused w/ flex outlet	10	WGDR13S	WGDR13SIG	WGDR13SNB	WGDR13SKB	WGDR13SEG
13A switched fused w/ flex outlet w/ LED	10	WGDR13SN	WGDR13SNIG	WGDR13SNNB	WGDR13SNKB	WGDR13SNEG

Remark: Grey reference product - coming soon

Hager Dream

5A and 10A socket outlets





- Complies with
SS 472 (5A socket)
BS 546 (5A socket)
IEC 60884-1(10A socket)

- Supplied with M3.5 x 37 mm
long fixing screws

- Capacity of each terminal:
L, N, E : 3 X 2.5 mm² or
2 X 4.0 mm²

- Integral rocker design of
switched sockets provides
clear red 'on' indication

- Material: Polycarbonate

	Description	Pack qty.	Cat. Ref. White	Cat. Ref. Interstellar Grey	Cat. Ref. Noble Bronze	Cat. Ref. Knight Black	Cat. Ref. Elegant Gold
 WGDS105S	Socket outlet 5A round pin switched	8	WGDS105S	WGDS105SIG	WGDS105SNB	WGDS105SKB	WGDS105SEG
 WGDS110US	10A 2 pin switched universal	10	WGDS110US	WGDS110USIG	WGDS110USNB	WGDS110USKB	WGDS110USEG
 WGDS210U	10A 2 pin + 2 pin universal	10	WGDS210U	WGDS210UIG	WGDS210UNB	WGDS210UKB	WGDS210UEG

Remark: Grey reference product - coming soon

Hager Dream

13A socket outlets

- Complies with
BS 1363-2
SS 145-2









- Supplied with M3.5 x 37 mm
long fixing screws

- Capacity of each terminal:
L, N, E : 3 X 2.5 mm² or
2 X 4.0 mm²

- USB output current
2.4A (Max)

- Integral rocker design of
switched sockets provides
clear red 'on' indication

- Material: Polycarbonate

	Description	Pack qty.	Cat. Ref. White	Cat. Ref. Interstellar Grey	Cat. Ref. Noble Bronze	Cat. Ref. Knight Black	Cat. Ref. Elegant Gold
 WGDS113	13A single	10	WGDS113	WGDS113IG	WGDS113NB	WGDS113KB	WGDS113EG
 WGDS113S	13A single switched	10	WGDS113S	WGDS113SIG	WGDS113SNB	WGDS113SKB	WGDS113SEG
 WGDS113N	13A single switched w/ LED	10	WGDS113N	WGDS113NIG	WGDS113NNB	WGDS113NKB	WGDS113NEG
 WGDS113SUSB	13A single switched 2 x USB chargers	8	WGDS113SUSB	WGDS113SUSBIG	WGDS113SUSBNB	WGDS113SUSBKB	WGDS113SUSBEG
 WGDS113S1USB	13A single switched 1 x USB chargers	8	WGDS113S1USB	WGDS113S1USBIG	WGDS113S1USBNB	WGDS113S1USBKB	WGDS113S1USBEG
 WGDS213	13A twin	10	WGDS213	WGDS213IG	WGDS213NB	WGDS213KB	WGDS213EG
 WGDS213S	13A twin switched	10	WGDS213S	WGDS213SIG	WGDS213SNB	WGDS213SKB	WGDS213SEG
 WGDS213N	13A twin switched w/ LED	10	WGDS213N	WGDS213NIG	WGDS213NNB	WGDS213NKB	WGDS213NEG
 WGDS213SUSB	13A twin switched 2 x USB chargers	10	WGDS213SUSB	WGDS213SUSBIG	WGDS213SUSBNB	WGDS213SUSBKB	WGDS213SUSBEG

Remark: Grey reference product - coming soon

- Complies with
BS 546 (15A socket)
SS 472 (15A socket)

IEC 60884-1
(German socket)
(Euro-American socket)







- Supplied with M3.5 x 37 mm
long fixing screws

- Capacity of each terminal:
L, N, E : 3 X 2.5 mm² or
2 X 4.0 mm²

- USB output current
2.4A (Max)

- Integral rocker design of
switched sockets provides
clear red 'on' indication

- Material: Polycarbonate

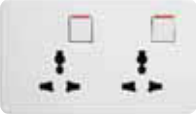
	Description	Pack qty.	Cat. Ref. White	Cat. Ref. Interstellar Grey	Cat. Ref. Noble Bronze	Cat. Ref. Knight Black	Cat. Ref. Elegant Gold
	15A round pin switched	8	WGDS115S	WGDS115SIG	WGDS115SNB	WGDS115SKB	WGDS115SEG
	16A German socket w/ shutter	8	WGDS116S	WGDS116SIG	WGDS116SNB	WGDS116SKB	WGDS116SEG
	16A single Euro-American	8	WGDS116EA	WGDS116EAIG	WGDS116EANB	WGDS116EAKB	WGDS116EAEG
	16A twin Euro-American	8	WGDS216EA	WGDS216EAIG	WGDS216EANB	WGDS216EAKB	WGDS216EAEG
	16A single switched universal	10	WGDS116IS	WGDS116ISIG	WGDS116ISNB	WGDS116ISKB	WGDS116ISEG
	16A single switched universal 2 x USB chargers	8	WGDS116ISUSB	WGDS116ISUSBIG	WGDS116ISUSNB	WGDS116ISUSBKB	WGDS116ISUSBEG
	16A twin switched universal	10	WGDS216IS	WGDS216ISIG	WGDS216ISNB	WGDS216ISKB	WGDS216ISEG

- Supplied with M3.5 x 37 mm long fixing screws











- Material: Polycarbonate





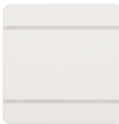

		Description	Pack qty.	Cat. Ref. White	Cat. Ref. Interstellar Grey	Cat. Ref. Noble Bronze	Cat. Ref. Knight Black	Cat. Ref. Elegant Gold
	WGDT1RJ	RJ11 outlet						
		1 mod	10	WGDT1RJ	WGDT1RJIG	WGDT1RJNB	WGDT1RJKB	WGDT1RJEJG
	WGDT2RJ	2 mod	10	WGDT2RJ	WGDT2RJIG	WGDT2RJNB	WGDT2RJKB	WGDT2RJEJG
		RJ45 outlet loose plate						
	WGDT1RJ6LP	1 mod	20	WGDT1RJ6LP	WGDT1RJ6LPIG	WGDT1RJ6LPNB	WGDT1RJ6LPKB	WGDT1RJ6LPEJG
		1 mod	20	WGDT1RJ6LPNM	WGDT1RJ6LPNIG	WGDT1RJ6LPNMB	WGDT1RJ6LPNKB	WGDT1RJ6LPNEJG
	WGDT2RJ6LP	2 mod	20	WGDT2RJ6LP	WGDT2RJ6LPIG	WGDT2RJ6LPNB	WGDT2RJ6LPKB	WGDT2RJ6LPEJG
		2 mod	20	WGDT2RJ6LPNM	WGDT2RJ6LPNIG	WGDT2RJ6LPNMB	WGDT2RJ6LPNKB	WGDT2RJ6LPNEJG
	WGDT1RJ6	RJ45 cat6 outlet						
		1 mod	10	WGDT1RJ6	WGDT1RJ6IG	WGDT1RJ6NB	WGDT1RJ6KB	WGDT1RJ6EJG
	WGDT2RJ6	1 mod	10	WGDT1RJ6NM	WGDT1RJ6NIG	WGDT1RJ6NMB	WGDT1RJ6NKB	WGDT1RJ6NEJG
		2 mod	10	WGDT2RJ6	WGDT2RJ6IG	WGDT2RJ6NB	WGDT2RJ6KB	WGDT2RJ6EJG
	WGDT2RJ6NM	2 mod	10	WGDT2RJ6NM	WGDT2RJ6NIG	WGDT2RJ6NMB	WGDT2RJ6NKB	WGDT2RJ6NEJG
		RJ45 cat5e outlet						
	WGDT1RJ5	1 mod	10	WGDT1RJ5	WGDT1RJ5IG	WGDT1RJ5NB	WGDT1RJ5KB	WGDT1RJ5EJG
		2 mod	10	WGDT2RJ5	WGDT2RJ5IG	WGDT2RJ5NB	WGDT2RJ5KB	WGDT2RJ5EJG
	WGDT2RJRJ5	RJ11 + RJ45 cat5e outlet						
		2 mod	10	WGDT2RJRJ5	WGDT2RJRJ5IG	WGDT2RJRJ5NB	WGDT2RJRJ5KB	WGDT2RJRJ5EJG
	WGDT2RJRJ6	RJ11 + RJ45 cat6 outlet						
		2 mod	10	WGDT2RJRJ6	WGDT2RJRJ6IG	WGDT2RJRJ6NB	WGDT2RJRJ6KB	WGDT2RJRJ6EJG
	WGDT1TV	TV inlet/outlet + RJ45 cat5e						
		2 mod	10	WGDT2TVRJ5	WGDT2TVRJ5IG	WGDT2TVRJ5NB	WGDT2TVRJ5KB	WGDT2TVRJ5EJG
	WGDT2TVRJ6	TV inlet/outlet						
		1 mod	10	WGDT1TV	WGDT1TVIG	WGDT1TVNB	WGDT1TVKB	WGDT1TVEJG
	WGDT1TVF	TV inlet/outlet + RJ45 cat6 (DATA marking)						
		2 mod	10	WGDT2TVRJ6	WGDT2TVRJ6IG	WGDT2TVRJ6NB	WGDT2TVRJ6KB	WGDT2TVRJ6EJG
	WGDT2TVFRJ6	TV outlet, F type						
		1 mod	10	WGDT1TVF	WGDT1TVFIG	WGDT1TVFNB	WGDT1TVFKB	WGDT1TVFEJG
	WGDT2TVFRJ6	TV outlet, F type + RJ45 Cat6 (DATA marking)						
		2 mod	10	WGDT2TVFRJ6	WGDT2TVFRJ6IG	WGDT2TVFRJ6NB	WGDT2TVFRJ6KB	WGDT2TVFRJ6EJG

- Complies with
IEC 60669-1
IEC 60669-2-1
IEC 62368-1 (USB)

- Supplied with M3.5 x 37 mm
long fixing screws

- Material: Polycarbonate

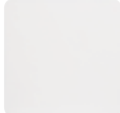
		Description	Pack qty.	Cat. Ref. White	Cat. Ref. Interstellar Grey	Cat. Ref. Noble Bronze	Cat. Ref. Knight Black	Cat. Ref. Elegant Gold
		16AX DND & 8 MUR with LED (Indoor)	8	WGDHDC	WGDHDCIG	WGDHDCNB	WGDHDCBK	WGDHDCG
WGDHDC	WGDHBD	4A DND & 10 MUR indicator w/ bell switch	10	WGDHBD	WGDHBDIG	WGDHBDNB	WGDHBDKB	WGDHBDG
		16A key tag - mechanical	6	WGDHKTM	WGDHKTMIG	WGDHKTMB	WGDHKTMBK	WGDHKTMEG
WGDHKTM WGDHKTRFID		16A key tag - RFID	6	WGDHKTRFID	WGDHKTRFIDIG	WGDHKTRFIDNB	WGDHKTRFIDKB	WGDHKTRFIDEG
HDMI+VGA								
			10	WGDHHIVA	WGDHHIVAIG	WGDHHIVANB	WGDHHIVAKB	WGDHHIVAEG
WGDHHIVA	WGDHRCASV		10	WGDHRCASV	WGDHRCASVIG	WGDHRCASVNB	WGDHRCASVKB	WGDHRCASVEG
RCA+S-Video								
		USB charger 4.2A (1 x type C) + (2 x type A)	8	WGDS3USB	WGDS3USBIG	WGDS3USBNB	WGDS3USBKB	WGDS3USBEG
WGDS3USB	WGDHUSB35		10	WGDHUSB35	WGDHUSB35IG	WGDHUSB35NB	WGDHUSB35KB	WGDHUSB35EG
USB + 3.5mm audio								
		Emergency switch	8	WGDEE1	WGDEE1IG	WGDEE1NB	WGDEE1KB	WGDEE1EG
WGDEE1	WGDEA6	Audio switch 6W	6	WGDEA6	WGDEA6IG	WGDEA6NB	WGDEA6KB	WGDEA6EG
		Sleeping light (0.25w)	8	WGDHSL	WGDHSLIG	WGDHSLNB	WGDHSLKB	WGDHSLG
WGDHSL	WGDHSR	Shaver socket 115/230V	1	WGDHSR	WGDHSRIG	WGDHSRNB	WGDHSRKB	WGDHSREG

Description	Pack qty.	Cat. Ref. White	Cat. Ref. Interstellar Grey	Cat. Ref. Noble Bronze	Cat. Ref. Knight Black	Cat. Ref. Elegant Gold	
Multi-gang frame							
 WGDCH2	2 gang horizontal	18	WGDCH2	WGDCH2IG	WGDCH2NB	WGDCH2KB	WGDCH2EG
 WGDCH3	3 gang horizontal	12	WGDCH3	WGDCH3IG	WGDCH3NB	WGDCH3KB	WGDCH3EG
 WGDCH4	4 gang horizontal	12	WGDCH4	WGDCH4IG	WGDCH4NB	WGDCH4KB	WGDCH4EG
 WGDCH5	5 gang horizontal	9	WGDCH5	WGDCH5IG	WGDCH5NB	WGDCH5KB	WGDCH5EG
Blank plate							
 WGDBP1	1 gang	20	WGDBP1	WGDBP1IG	WGDBP1NB	WGDBP1KB	WGDBP1EG
WA covers (Transparent)							
 XC9003	IP55 single size	40	XC9003				
 XC9004	IP55 twin size	40	XC9004				

Compliance with standards

Regulation 511-01-01 of BS 7671 : Requirements for Electrical Installations, IEE Wiring Regulations Sixteenth Edition is of particular importance to specifiers and installers with respect to product standards.

Regulation 511-01-01 requires every item of equipment to comply with the relevant requirements of the applicable British Standard, or Harmonised Standard appropriate to the intended use of the equipment.

British Standards (BS)

The BSI (British Standards Institution) was the first national standards body in the world. There are now more than 100 similar organisations which belong to the International Organisation for Standardisation (ISO) and the International Electrotechnical Commission (IEC).

British Standards are drawn up by all those who have a particular interest in the subject i.e. manufacturers, users, research organisations, government departments and consumers. This work is co-ordinated by BSI staff, acting as secretaries to the committees where the work is done. All standards are made available for public comment before they are published.

Harmonised standards

A Harmonised standard is a European standard formally presented by CENELEC, to the European Commission and published in the commission's official journal. CENELEC is the Comité Européen de Normalisation Electrotechnique i.e. European Committee for Electrotechnical Standardisation.

BS 7671 part 2 defines a harmonised standard as a standard which has been drawn up by common agreement between national standards bodies notified to the European Commission by all member states and published under national procedures. The UK national standards body is the British Standards Institution. In the UK a harmonised standard will normally be published as a British Standard European Norm i.e. BS EN.

British Standard European Norm (BS EN)

CENELEC European standards are pre-fixed EN (European Norm). Adoption of the European Standard within the EC is mandatory and member countries of CENELEC are obliged to publish them unchanged. In the UK such standards are further endorsed with the additional prefix 'BS', for example BS EN 60669-1 : 1996 is the British Standard European Norm for Switches for household and similar fixed electrical installations.

Whilst a European Standard can be a direct replica of an IEC standard, discussions within CENELEC may result in the formulation of a standard which includes commonly agreed variations and Special National Conditions.

International Electrotechnical Commission (IEC)

Founded in 1906 the International Electrotechnical Commission (IEC) is the world organisation that prepares and publishes international standards for all electrical, electronic and related technologies. The membership consists of 60 participating countries, including all the world's major trading nations and a growing number of industrialising countries.

Foreign national standards based on IEC standards are permitted to be used by BS 7671. However the specifier must verify that any differences between the foreign standard and the corresponding British Standard or Harmonised Standard does not result in any lesser degree of safety than that afforded by compliance with the British Standard. This assessment would probably need to be made by specialists.

Conclusion

BS 7671 (IEE Wiring Regulations) recognises equipment which complies with a British Standard or Harmonised Standard appropriate to the intended use of the equipment without the need for further qualification.

Hager products have always been designed and manufactured to a high standard to ensure compliance with the current British or Harmonised Standard. See the table below for further information. Modiam in utetuoero commolumsan vullamet nonulput luptat nim ipit nit nit irit, voloreet velit, quam do estrud modoles equatet veliscilit in ulputpat. Dui tatisse quisi.

Product description	BS / IEC number	Description
Switches	BS EN 60669-1 IEC 60669-1 CB certificate	Switches for household and similar fixed electrical installations
Indicators	BS 5733	General requirements for Electrical Accessories
Fused connection unit, cord outlets	BS 5733	Switches for household and similar fixed electrical installations with particular requirements for timedelay switches (TDS)
Dimmers	BS EN 60669-2-3	Switches for household and similar fixed electrical installations with particular requirements for timedelay switches (TDS)
Frames and plates	BS 5733	Switches for household and similar fixed electrical installations with particular requirements for timedelay switches (TDS)
10 Amp Wall switch	BS EN 60669-1 IEC 60669-1 CB certificate	Switches for household and similar fixed electrical installations
Dimmer switches	BS EN 60669-2-1 IEC 60669-2-1	Electronic variable control switches (dimmer switches) for tungsten filament lighting
13 Amp Socket Outlets	BS 1363- 2 SS145-2	13A plugs, socket-outlets, adaptors and connection units
15 Amp Switched Socket	BS 546 SS472 MS1577	Specification. Two-pole and earthing-pin plugs, socket-outlets and socket-outlet adaptors
20 Amp D.P. Switches	BS EN 60669-1 IEC 60669-1 CB certificate	Switches for household and similar fixed electrical installations
13 Amp Fused Connection Unit	BS 1363-4	Specification for 13A fused connection units switched and unswitched
45 Amp D.P. Switches	BS EN 60669-1 IEC 60669-1 CB certificate	Switches for household and similar fixed electrical installations
45 Amp Cooker Control Unit	BS 4177	Cooker control units
Shaver Socket Outlet	BS EN 61558-2-5 IEC 61558-2-5	General Requirements Isolating transformers and safety isolating transformers Electromagnetic compatibility, immunity requirements for household CB certificate appliances tools and similar apparatus.
25 Amp/ Amp Flex Outlet Plate	BS 5733	General Requirements for Electrical Accessories
BS Batten	BS EN 61184 IEC 61184 BS EN 60238 IEC 60238	Home office shield are T2 rated
Ceiling rose	BS 67	

Objective of CE marking.

CE marking is a “technical passport” which indicates that a product conforms to all relevant directives which require CE marking, thus enabling the product to travel within the E.U.

A directive is a piece of mandatory European Legislation implemented by regulations in all member countries. Its purpose is to allow free movement of goods that are safe and fit for use into and within the European Union.

CE marking is not a quality mark and it does not indicate that any testing or certification has been carried out.

The marking.

CE marking is a statement by the manufacturer that the product complies with the essential requirements of all relevant Directives, notably in the area of technical safety and conformity assessment.

CE marking can appear on the product or packaging or documentation or combination thereof dependant upon which directive it has to comply with.

CE marking is a very specific graphical symbol and must be clearly separated from other marks.

**Directives.**

It is the responsibility of the manufacturer or his authorised representative who places the product onto the EC market to decide which Directive(s) apply and to ensure the CE marking is affixed by the dates stated in the relevant directive(s)

For the majority of Hager products only one directive is applicable this is referred to as the Low Voltage Directive. Where some products incorporate electronic devices the Low voltage Directive and the Electromagnetic Compatibility Directive are applicable.

The low voltage directive.

EC directives are requirements adopted by the European Council and published in the official journal of the European Communities and are addressed to the member states.

European Council Directive 73/23/EEC with an amendment 93/68/EEC is known as the Low Voltage Directive.

The low voltage directive has been implemented into UK law by the “Electrical Equipment (Safety) Regulations 1994” and apply to all electrical / electronic equipment operating at a voltage of 50-1000 V a.c. or 75-1500 V d.c.. They do not apply to plugs, socket outlets and adapters which are covered by the Plugs and Sockets (Safety) Regulations 1994.

Relationship between the Electrical Equipment (Safety) Regulations, Harmonised standards and the IEE Wiring Regulations Sixteenth Edition.

The Electrical Equipment (Safety) Regulations requires electrical equipment to be safe. Electrical equipment which satisfies the safety provisions of Harmonised standards shall be taken to comply with this requirement, unless there are reasonable grounds for suspecting that the equipment does not so comply.

Regulation 511-01-01 of BS 7671 Requirements for Electrical Installations, IEE Wiring Regulations Sixteenth Edition requires every item of equipment to comply with the relevant requirements of the applicable British Standard, or Harmonised Standard appropriate to the intended use of the equipment.

The Ingress Protection (IP) for all low voltage enclosures up to 1000 V a.c. and 1500 V d.c. is defined in identical fashion by the standards EN 605 29 - IEC 529 it comprises the letters IP followed by two character numerals:



The first character numeral indicated the degree of protection provided by the enclosure with respect to persons, also to the equipment inside the enclosure.

The second character numeral indicated the degree of protection provided by the enclosure with respect to harmful ingress of water; a third character may be used to indicate mechanical strength. An x signifies that no test has been carried out.

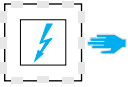
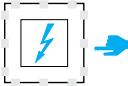
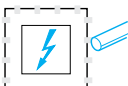
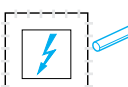
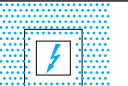
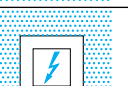
The first character numeral:
protection against solid substances

IP	Description
0	Non-protected
1	 Protected against solid objects greater than 50mm
2	 Protected against solid objects greater than 12.5mm
3	 Protected against solid objects greater than 2.5mm
4	 Protected against solid objects greater than 1.0mm
5	 Dust-protected
6	 Dust-tight

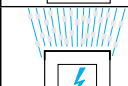
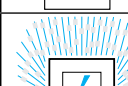
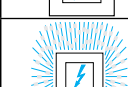
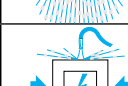
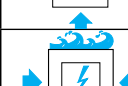
The second character numeral:
protection against liquid substances

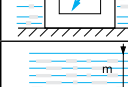
IP	Description
0	Non-protected
1	 Protected against dripping water
2	 Protected against dripping water when tilted up to 15°
3	 Protected against spraying water
4	 Protected against splashing water
5	 Protected against water jets
6	 Protected against heavy seas
7	 Protected against the effect of immersion
8	 Protected against submersion

Additional letter (in option)

Protection of people against access to dangerous parts

	Description
A	Protected against access of the back of the hand
B	Protected against access of a finger
C	Protected against access of a tool - ø 2.5mm
D	Protected against access of a tool - ø 1mm

Additional letter (in option)

Specific information on the product

	Description
H	High voltage material
M	Movements during water test
S	Stationary during water test
W	Bad weather

One way switch

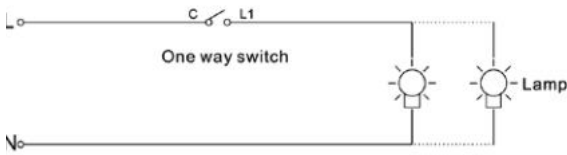

Two way switch

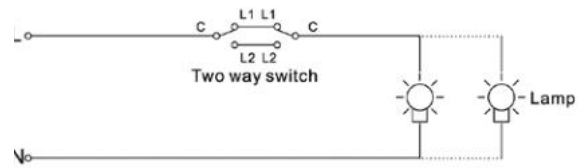

Marked BELL switch

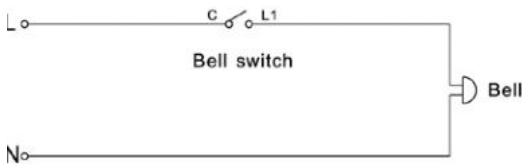

Marked PRESS switch

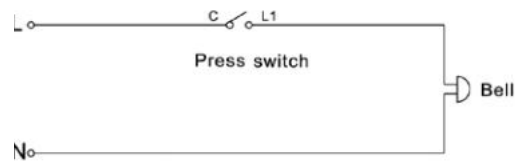

Intermediate switch

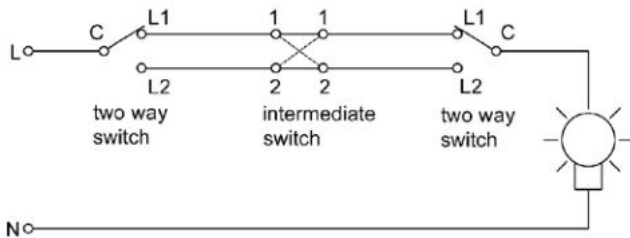

Fan control

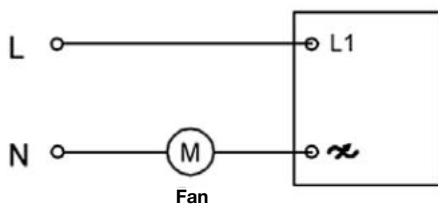

Audio switch

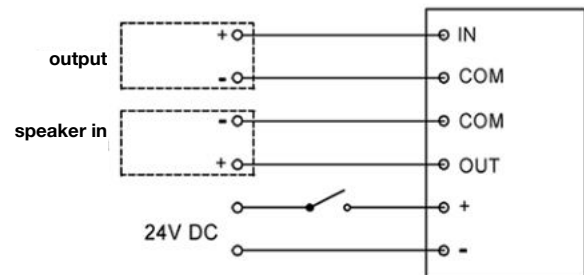

Dimmer switch

1. One way connection

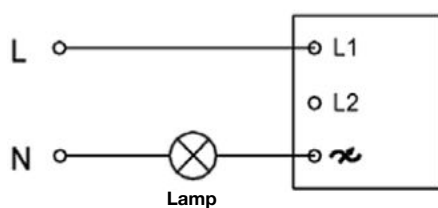

2. Two way connection

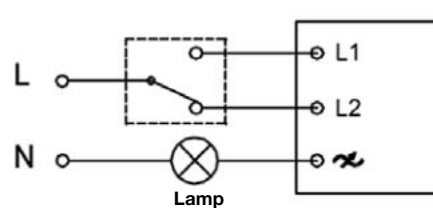

Do not disturb and please clean the switch (inside the door) / Do not disturb and please clear the instructions and the doorbell switch (outside the door)

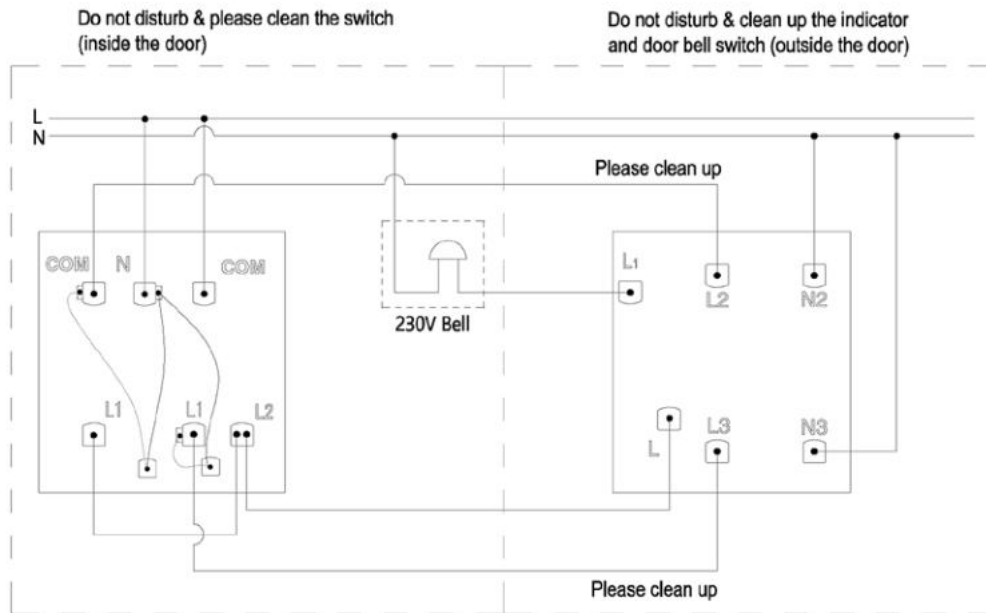

RJ45 Computer module cable diagram EIA/TIA 568B

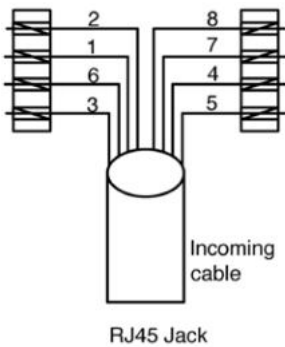

RJ45 Jack pin. EIA/TIA 568B	EIA/TIA 568
1 White/Orange	White/Green
2 Orange	Green
3 White/Green	White/Orange
4 Blue	Blue
5 White/Blue	White/Blue
6 Green	Orange
7 White/Brown	White/Brown
8 Brown	Brown

RJ11 Telephone plug-in module cable diagram

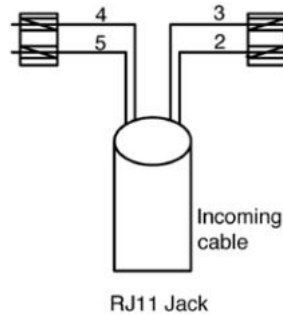

RJ11 Jack pin.

2 Blue/White
3 White/Blue
4 White/Red
5 Red/White

Key card
Direct load

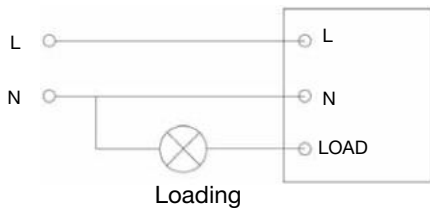

Key card
Connected load through contactor

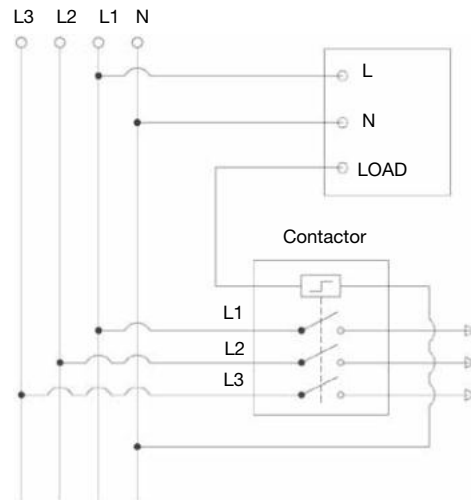

Residential application

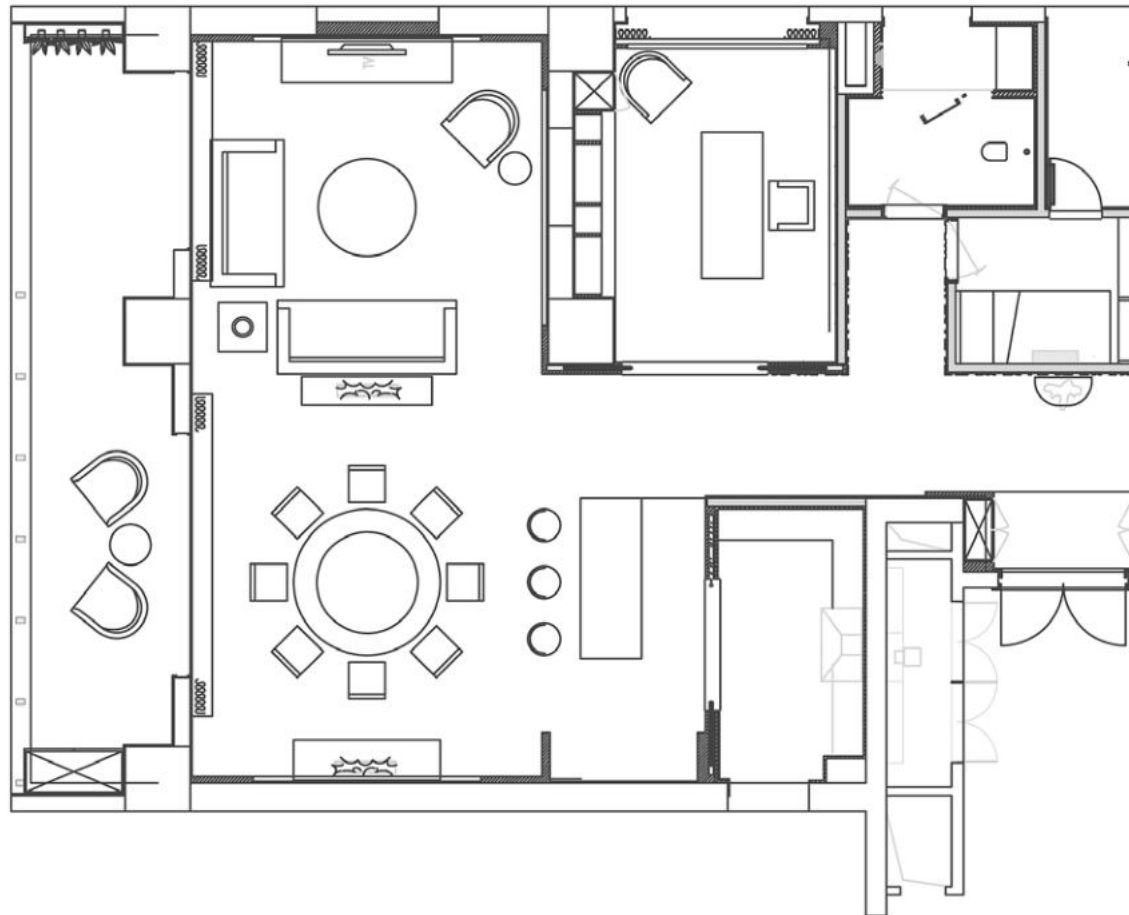

Home garden / dining room

Product catalog

200W Infrared sensor switch fire control	1
13A single switched socket	2
13A twin socket	2
13A single switched socket + 2 x USB chargers	1
16AX 1 gang 1 way switch	1
16AX 2 gang 2 way switch	1
16AX 2 gang 1 way switch	1
RJ11 outlet, 1 mod	1
RJ45 cat6 outlet	1
TV outlet, 1 mod	1
2 gang horizontal frame	2
5 gang horizontal frame	1

Restaurant / kitchen

Product catalog

Product catalog	QTY
13A single switched socket	8
13A twin socket	2
13A single switched socket + 2 x USB chargers	1
16AX 2 gang 2 way switch	1
16AX 2 gang 1 way switch	1
TV outlet, 1 mod	1
3 gang horizontal frame	2

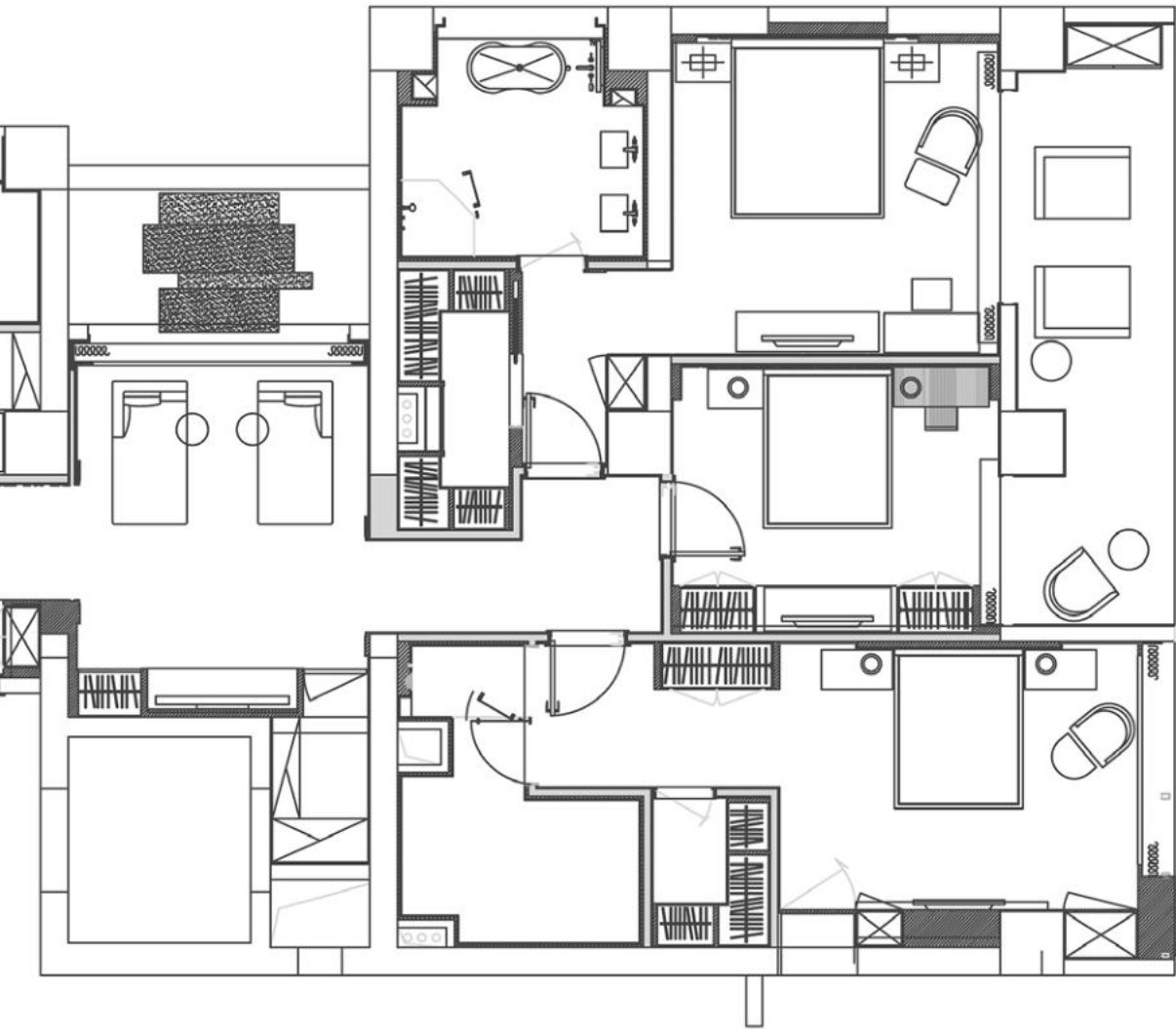

Bedroom / dressing room / study room

Product catalog

- 10AX 1 gang intermediate
- 13A twin socket
- 13A single switched socket + 2 x USB chargers
- 16AX 2 gang 1 way switch
- RJ11 outlet, 1 mod
- RJ45 cat6 outlet
- TV outlet, 1 mod
- Sleeping light

QTY

- 2
- 2
- 1
- 1
- 1
- 1
- 1
- 2

Bathroom / balcony

Product catalog

- 16AX 2 gang 1 way switch
- 13A single switched socket
- Blank plate
- WA cover (IP55)

QTY

- 1
- 2
- 4
- 2

Hotel application

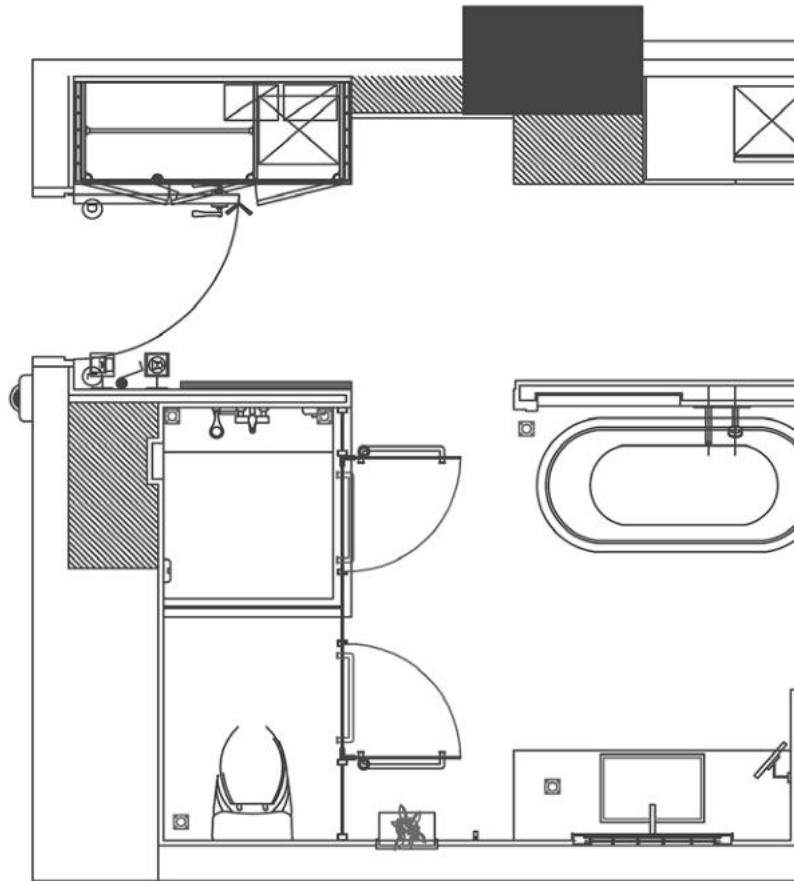

Entrance / Bar counter

Product catalog

- 4A DND & MUR indicator w/ bell switch
- 16A key tag RFID
- 16AX 1 gang 1 way LED switch
- 16AX 2 gang 2 way LED switch
- 13A single switched socket

QTY

- 1
- 1
- 1
- 1
- 3

Bed

Product catalog

- 16AX 2 gang 1 way w/ LED switch
- 13A single switched socket, 2 x USB chargers
- 13A single socket
- 40-500W 2 way dimmer
- RJ11 outlet, 1 mod
- RJ45 ca5e outlet
- Sleeping light

QTY

- 1
- 1
- 2
- 2
- 1
- 1
- 1

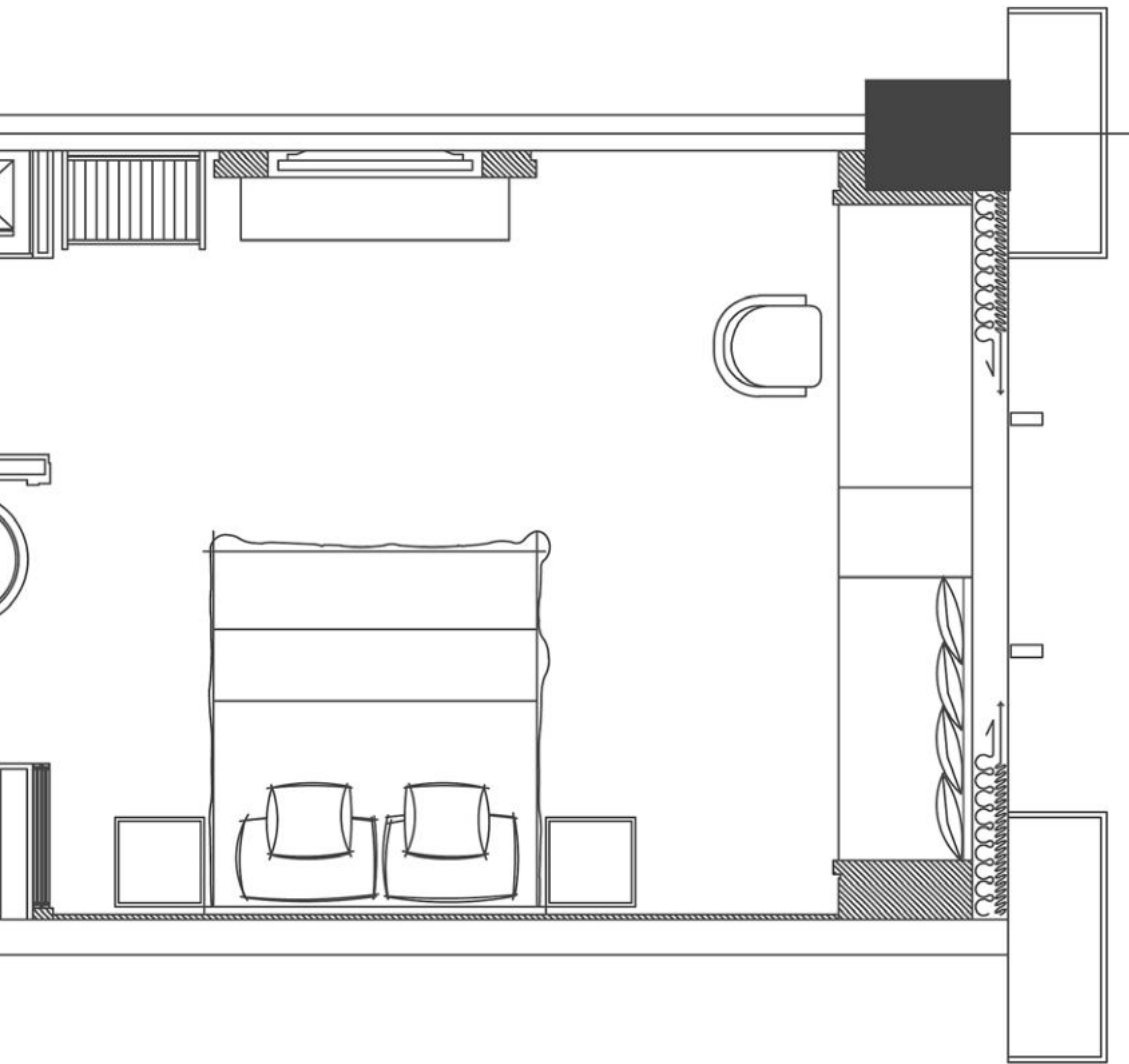

Desk

Product catalog

- 16AX 2 gang 1 way w/ LED switch
- HDMI+VGA
- 13A single switched socket + 2 x USB chargers
- 13A single socket
- RJ11 outlet, 1 mod
- RJ45 cat6 outlet

QTY

- 1
- 1
- 1
- 2
- 1
- 1

Bathroom

Product catalog

- 16AX 2 gang 1 way w/ LED switch
- Shaver socket
- Sleeping light
- SOS emergency switch
- 6W Audio switch
- 13A single switched socket
- RJ11 outlet, 1 mod
- WA cover (IP55)

QTY

- 2
- 1
- 1
- 1
- 1
- 3
- 1
- 4

Office application

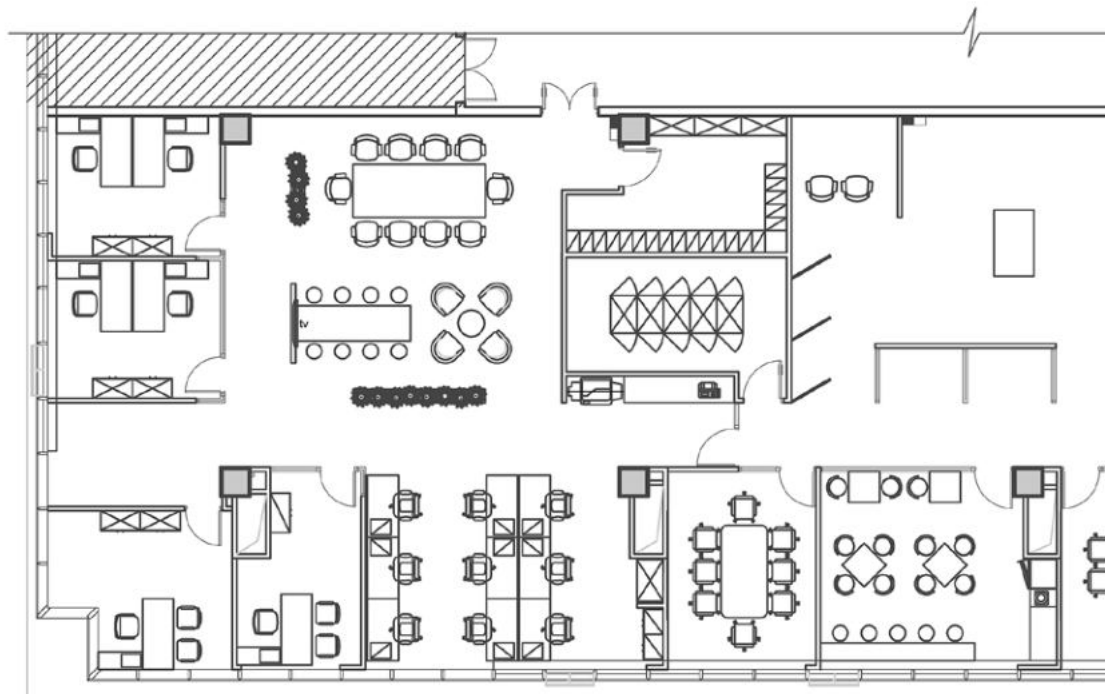

Single office

Product catalog

16AX 1 gang 1 way switch	8
16AX 2 gang 2 way switch	16
13A single switched socket	48
13A single switched socket + 2 x USB chargers	8
RJ45 cat6 outlet	16
HDMI+VGA	8
6A Audio switch	8
2 gang horizontal frame	16
3 gang horizontal frame	16

Open area office

Product catalog

Product catalog	QTY
16AX 1 gang 1 way switch	6
16AX 3 gang 1 way switch	10
16AX 4 gang 1 way switch	8
13A single switched socket	100
RJ11+RJ45 ca5e outlet	50
6A Audio switch	8
2 gang horizontal frame	6
3 gang horizontal frame	54

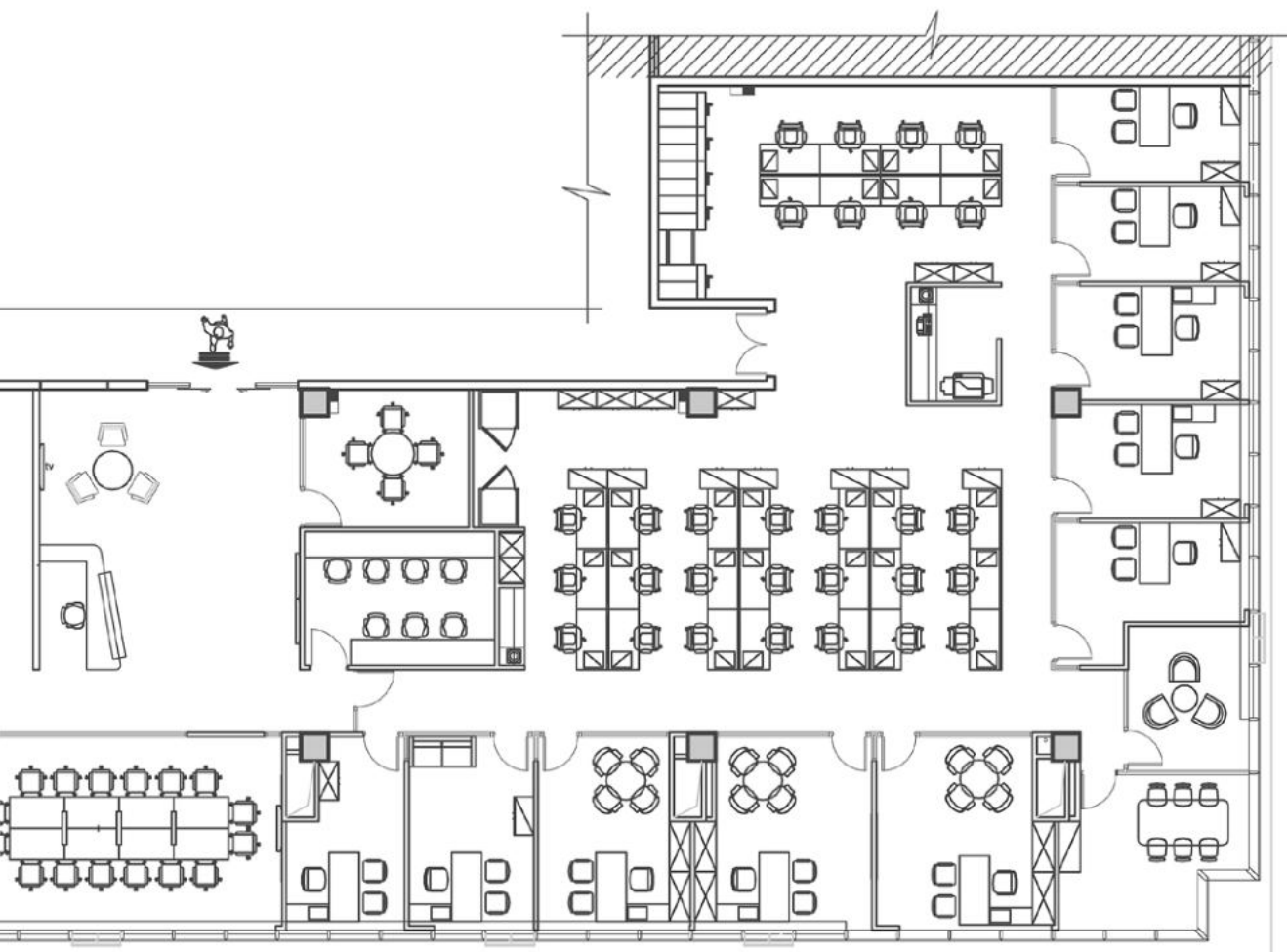

Meeting room

Product catalog

16AX 1 gang 1 way switch	2
16AX 2 gang 1 way switch	4
16AX 3 gang 1 way switch	4
13A single switched socket	20
RJ11 outlet	2
RJ45 ca6 outlet	12
HDMI+VGA	1
3 gang horizontal frame	6
4 gang horizontal frame	54

Public area:

reception/ corridor/ pantry/ washroom

Product catalog	QTY
Sleeping light	12
13A single switched socket	12
200W Infrared sensor switch fire control	16
WA cover (IP55)	4

Success cases

The courage to try to innovate in architectural design; the design of excellence always brings together a lot of ideas; the pursuit of the ultimate detail and the admiration of superior quality. Today, whether in Munich, Berlin and Hamburg, or in Bolzano, Madrid and Seoul, these ideas can be traced in any building in the world. It is no coincidence that Hager switches and systems can be found in all of these places.

China

Sofitel Shenyang Lido, Shenyang
New World Beijing Hotel, Beijing
Fairmont Beijing, Beijing
Marriott Nanjing South Hotel, Nanjing
Grand Hyatt, Hangzhou
Park Hyatt Ningbo Resort & Spa, Ningbo
The Peninsula, Shanghai
Le Royal Meridien Hotel, Shanghai
Swissôtel Grand Shanghai, Shanghai
Mandarin Oriental Pudong, Shanghai
Sofitel Shanghai Sheshan Oriental, Shanghai
JW Marriott, Hangzhou
Four Points by Sheraton Bijie, Guizhou
Kempinski Hotel, Yinchuan
New World Wuhan Hotel Wuhan
Mandarin Oriental Hotel Guangzhou
Hyatt Place Shenzhen Airport, Shenzhen
The Ritz-Carlton, Shenzhen
InterContinental, Shenzhen
Swissôtel, Foshan
Shangri-La's Sanya Resort & Spa, Hainan

Hong Kong & Macau

Sheraton Hotel Tung Chung
Island Shangri-La, Hong Kong
Penta Hotel
Hotel ICON
Royal Plaza Hotel
Ritz Cariton Hotel
Best Western Hotel (Causeway bay & Tsim Sha Tsui)
Harbour Grand Hong Kong
Hyatt Regency Hotel
Harbourview Horizon Hotel
Royal View Hotel
Grand Lisboa Macau
Studio City Macau
Galaxy Macau

Singapore

Grand Hyatt Hotel
Goodwood Park
Park Regis
Ramada & Days Hotel Singapore at Zhongshan Park
Hotel Fort Canning

Malaysia

Genting Hotel, Genting Highlands
JW Marriott Hotel, Kuala Lumpur
WEIL Hotel Ipoh, Perak
Alila Bangsar Kuala Lumpur, Kuala Lumpur
Hilton Garden Inn Puchong, Selangor
Alwaqf Hotel, Kelantan
Kimberley Hotel, Penang
Iconic Hotel, Penang
VE Hotel & Residence, Bangsar South, Kuala Lumpur

Indonesia

Westin Hotel, Jakarta
Courtyard by Marriott, Bali
Fairfield by Marriott Sunset Road, Bali
The Ritz-Carlton, Bali Resort & Spa, Bali

Vietnam

Novotel Nha Trang
Sealink Phan Thiet
Sheraton Da Nang
Radison Blu Cam Ranh
Movenpick Cam Ranh
Melia Cam Ranh
Hanoi Hotel

India

Taj Palace, Mumbai
Hyatt Place, Hyderabad
Ritz Carlton Pune, Pune
Lemon Tree, 3 hotels (Udaipur, Dehradun, Kolkata)
Fairfield Marriott Kolkata, Kolkata

Europe

Hotel Sacher, Vienna
Hotel Lux Alpinae, St. Anton am Arlberg
Hotel Schloss Elmau, Elmau
Vigilius Mountain Resort, Lana
Hotel Puerta l'America, Madrid
Lloyd Hotel, Amsterdam
Zentrum für Virtuelles
Engineering ZVE, Stuttgart
Herzogin Anna Amalia Bibliothek, Weimar
minimum bulthaup, Berlin
Privathaus, Berlin
Hyatt Regency, Istanbul
i li Marriott, Istanbul
Sheraton Ate ehir, Istanbul
Swissôtel, Istanbul
Le Meridien, Istanbul
Hilton, Izmir
Crowne Plaza, Istanbul

Other Countries

Sedona Hotel, Mandalay, Myanmar
Four Seasons Hotel, Seychelles
Makati Shangri-La Hotel, Manila





Hager Dream



Hager Silhouette



Berker R.1

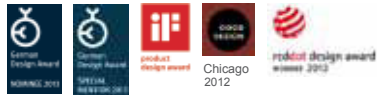

Berker R. Classic

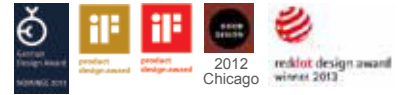

hagerblu visage



Berker B.IQ

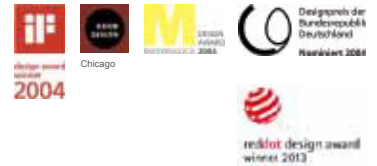

Hager golf



Hager witty



Hager Design turns technical products into familiar friends.



International designer Erwin van Handenhoven has been working with Hager since 2000 and his designs have repeatedly won international design awards. Erwin became the product design director of Hager Group in 2013, focusing on shaping the future of Hager products and brands, making Hager design an international vane.

Before we start designing a new product, we think about the people it is going to serve. Will it assist or entertain, observe or protect, save time or save energy? Ideally, whatever it does, users will feel it is a reliable "friend". We need to know how to connect with people on an emotional level, to ensure that in return they feel connected to our products.

Design links exquisite emotions to great usability and quality. How to illustrate this better than through this new HAGER range? I designed it with special care to become a real trendsetter for good taste. We know that the Asian continent is constantly raising his design sensibility and quality expectations. It is exciting to create in this particular context where tradition and change operate together. This new design range will upgrade the standard of living in a clearly visible way. Hope you enjoy it as much as I do.

Erwin van Handenhoven

Corporate Design Director of Hager Group
Hager Group Design Director



Distributed By

Choo Chiang Marketing Pte Ltd

(a subsidiary of Choo Chiang Holdings Ltd)
Tel: +65 6368 5922 | fax: +65 6363 5922
Head Office: 10 Woodlands Loop S(738388)

website: www.choochiang.com | facebook: facebook.com/choochiang.sg

